

Declinazione magnetica:
 Magnetic variation:
 3° E 2020,0

MODELLO MAGNETICO ITALIANO 2015
 Italian Magnetic Model 2015

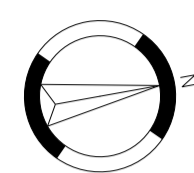

Annual rate of change: 0° E

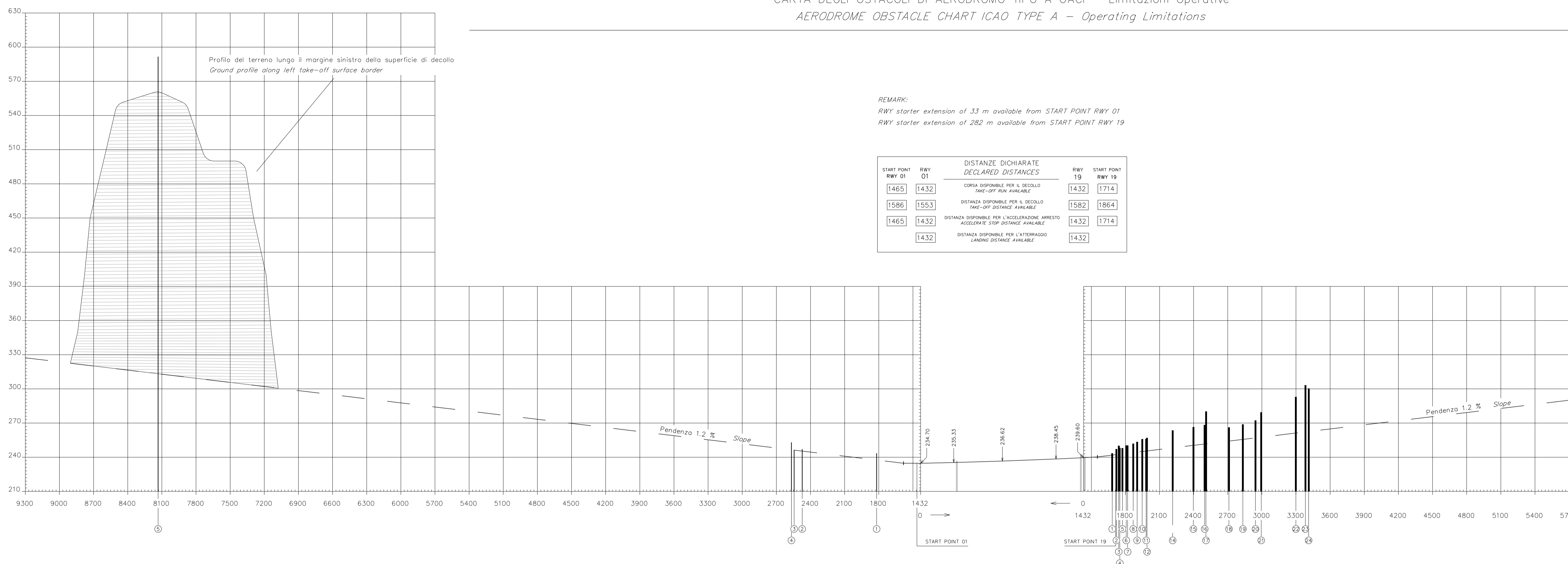

REMARK:
 RWY starter extension of 33 m available from START POINT RWY 01
 RWY starter extension of 282 m available from START POINT RWY 19

START POINT RWY 01	RWY 01	DISTANZE DICHIARATE / DECLARED DISTANCES	RWY 19	START POINT RWY 19
1465	1432	CORSA DISPONIBILE PER IL DECOLO / TAKE-OFF RUN AVAILABLE	1432	1714
1586	1553	DISTANZA DISPONIBILE PER IL DECOLO / TAKE-OFF DISTANCE AVAILABLE	1582	1864
1465	1432	DISTANZA DISPONIBILE PER L'ACCELERAZIONE ARRESTO / ACCELERATE STOP DISTANCE AVAILABLE	1432	1714
	1432	DISTANZA DISPONIBILE PER L'ATERRAGGIO / LANDING DISTANCE AVAILABLE	1432	

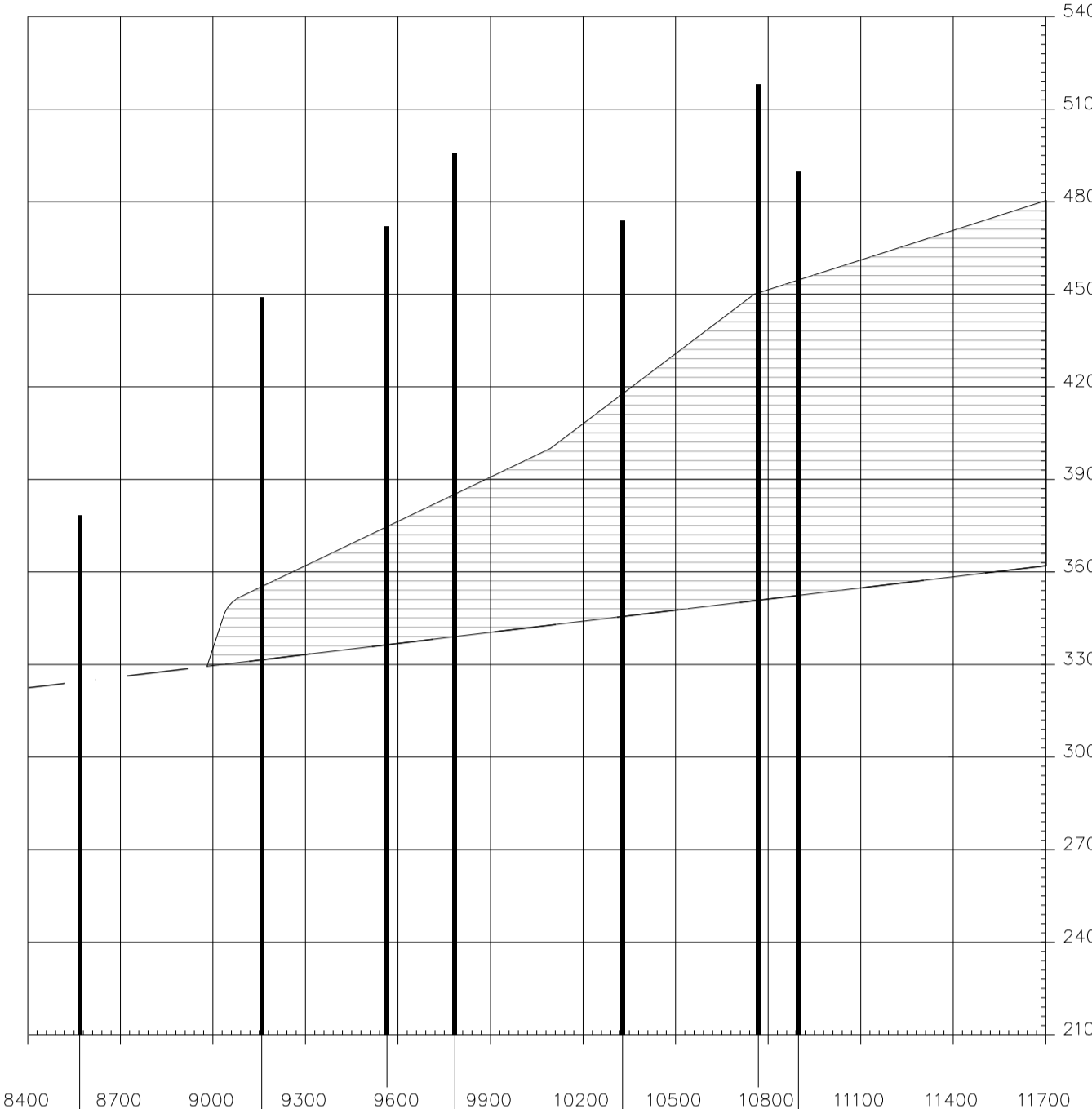
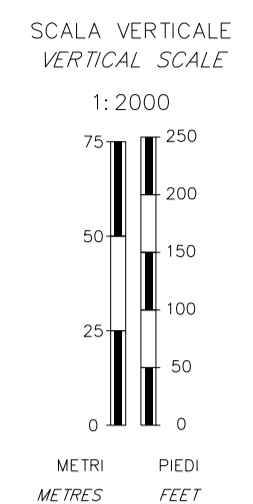

CONSULTARE I NOTAM PER LE ULTIME INFORMAZIONI
 CONSULT NOTAM FOR LATEST INFORMATION

LEGENDA / LEGEND	PIANTA / PLAN	PROFLO / PROFILE
Numero di identificazione / Identification number	①	①
Profilo ostacoli situati nell'area di decollo / Obstructions within the take-off flight path area		
Profilo ostacoli situati fuori dell'area di decollo / Obstructions beyond the take-off flight path area		
Altitudine dell'ostacolo ed altezza dell'antenna se esistente / Obstacle altitude and antenna height if available	56+1.5	
Edificio o costruzione importante / Building or large structure	■	
Polo, torre, campanile, antenna, cimitero / Pole, tower, spire, antenna, chimney	●	
Traliccio / Lattice	⊥	
Grù / Crane	⊙	
Albero, o arbusto – Gruppo di alberi / Tree or shrub – Wooded area	* / *	
Centro abitato / Built-up area	■	
Ferrovia (uno o due binari) / Railroad (one or more tracks)	—+—	
Linea trasporto energia elettrica – cavo sospeso / Transmission line – Overhead cable	—+—	
Recinzione / Fence	—+—	
Terreno sporgente dal piano ostacoli / Terrain penetrating obstruction plane	⬆	

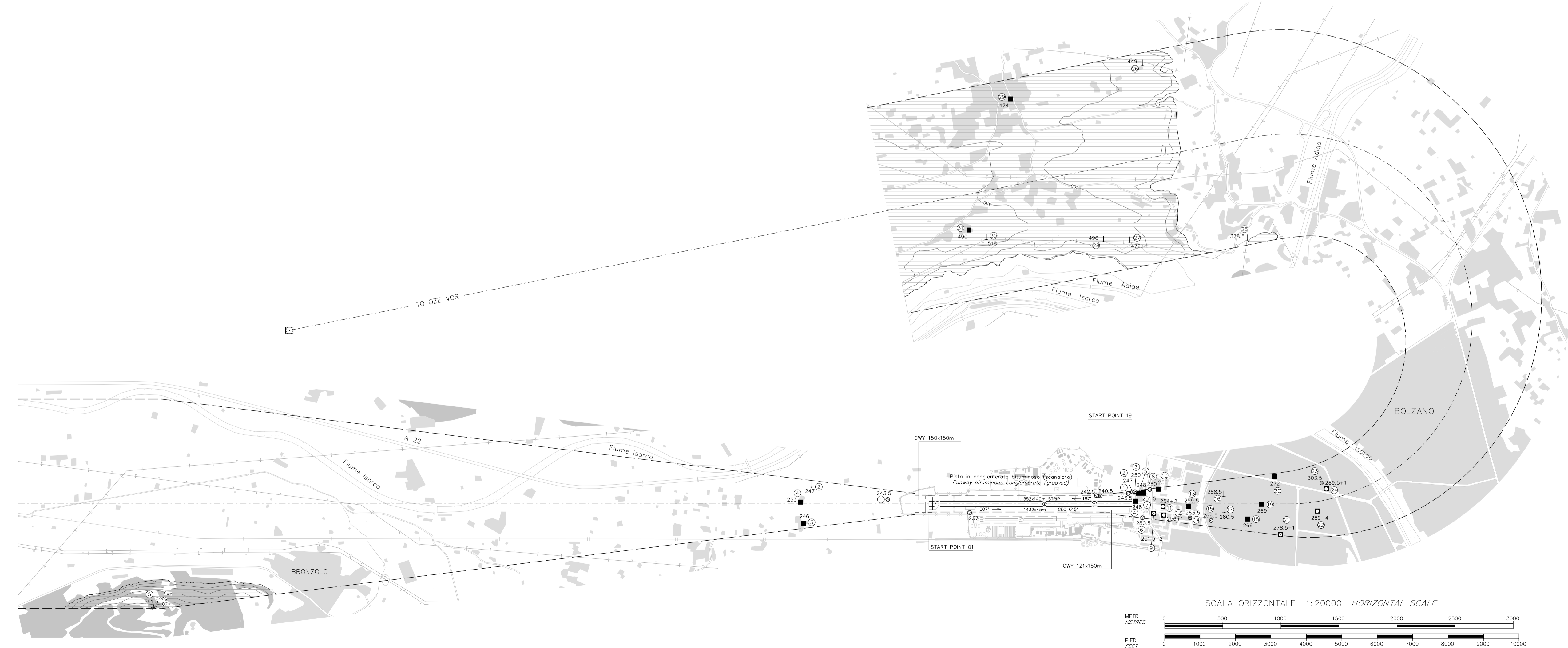

1) Area della traiettoria di volo in decollo RWY 01
 T.O.F.P.A RWY 01 in curva
 Posizione del centro di curvatura 1620m dopo la RWY END 01, 1590m a sinistra della RCL

1) Take-Off Flight Path Area RWY 01
 T.O.F.P.A. RWY 01 in curve
 Curve centre positioned 1620m after RWY END 01, 1590m on the left of RCL

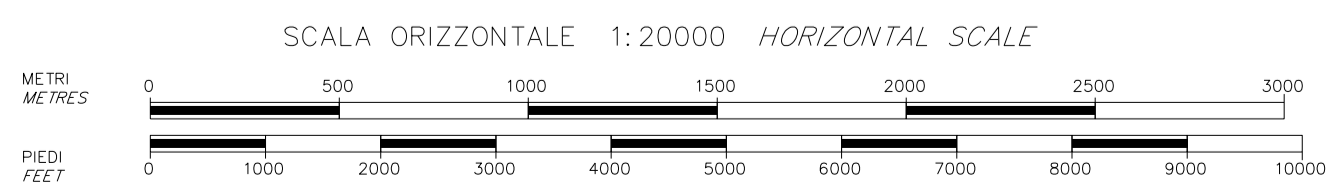

Le precisioni della carta sono quelle descritte nell'Annesso 4 ICAO, Capitolo 3.9
 Accuracies on the chart are specified in ICAO Annex 4, Chapter 3.9

VARIANTI / AMENDMENT RECORD	REGISTRATO DA / ENTERED BY
N. / DATA / DATE	

CARTA DEGLI OSTACOLI DI AERODROMO TIPO A OACI - Limitazioni Operative
AERODROME OBSTACLE CHART ICAO TYPE A - Operating Limitations

Declinazione magnetica:
Magnetic variation:
3° E 2020.0

MODELLO MAGNETICO ITALIANO 2015
Italian Magnetic Model 2015

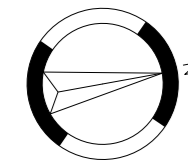

Annual rate of change: 8" E

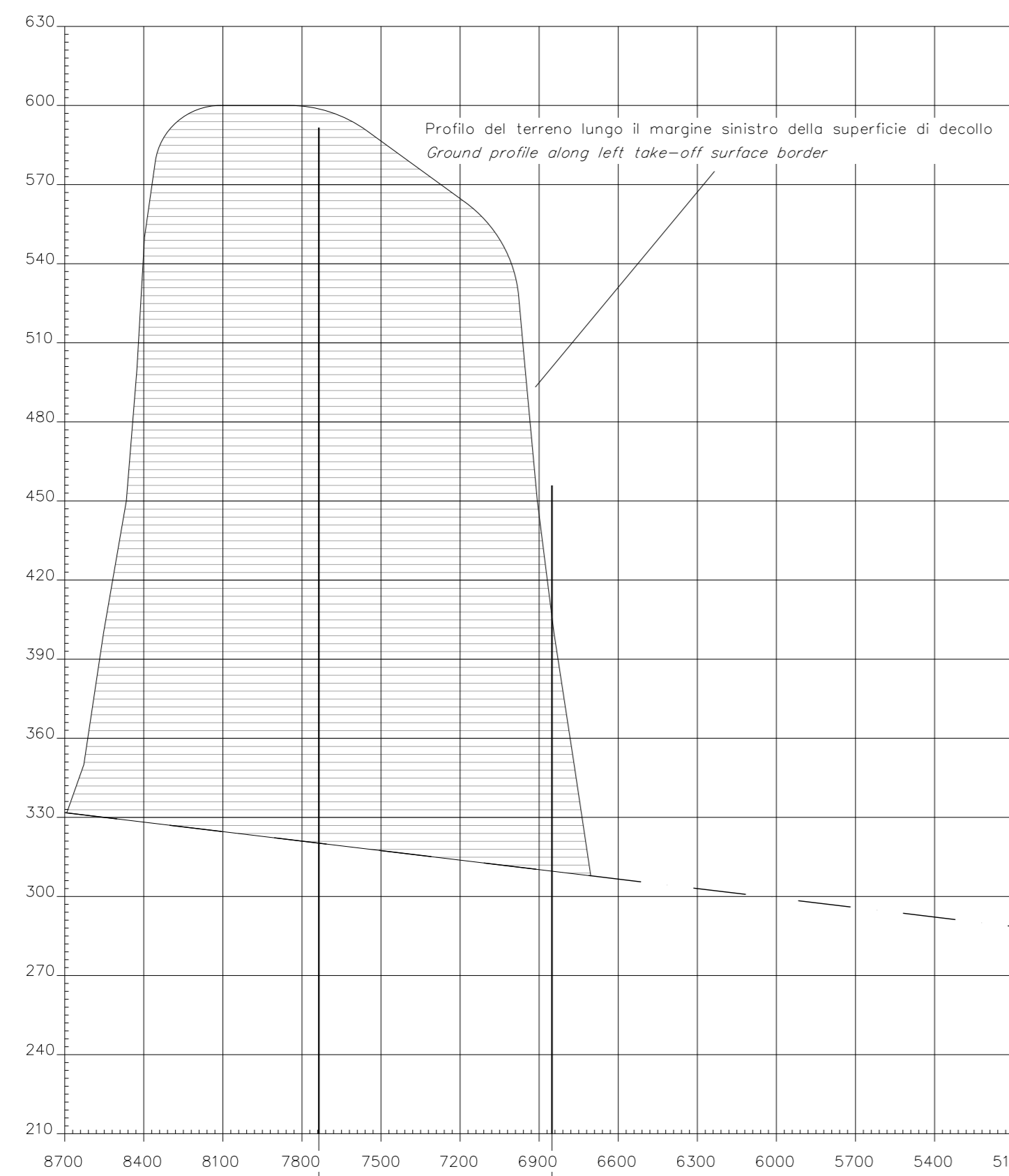

REMARK:
RWY 01/19: on pilot's request it is allowed for TKOF the use of pavement, RESA included, with the following declared distances as follows:

RWY OACI	DISTANZE DICHIARATE DECLARED DISTANCES	RWY IQUID
653	CORSA DISPONIBILE PER L'ECCELLO TAKE-OFF RUN AVAILABLE	653
653	DISTANZA DISPONIBILE PER IL DECOLLO TAKE-OFF DISTANCE AVAILABLE	653
653	DISTANZA DISPONIBILE PER L'ACCELERAZIONE ACCELERATE & STOP DISTANCE AVAILABLE	653
653	DISTANZA DISPONIBILE PER L'ATERREGGIO LANDING DISTANCE AVAILABLE	402

Profilo del terreno lungo il margine sinistro della superficie di decollo
Ground profile along left take-off surface border

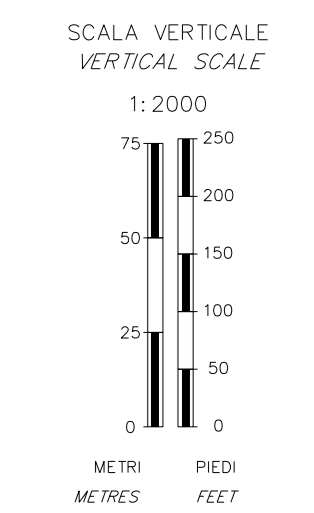

CONSULTARE I NOTAM PER LE ULTIME INFORMAZIONI
CONSULT NOTAM FOR LATEST INFORMATION

LEGENDA	LEGEND	PIANTA PLAN	PROFLO PROFILE
Numero di identificazione Identification number		①	①
Profilo ostacoli situati nell'area di decollo Obstructions with in the take-off flight path area			
Profilo ostacoli situati fuori dell'area di decollo Obstructions beyond the take-off flight path area			
Altitudine dell'ostacolo ed altezza dell'antenna se esistente Obstacle altitude and antenna height if available	56+1.5		
Edificio o costruzione importante Building or large structure	■		
Poste, torri, cimiteri, antenne, cimiteri Pole, towers, grave, antenna, cemetery	○		
Traffico Traffic	⊥		
Croce Cross	+		
Albero, o arbusto - Gruppo di alberi Tree or shrub - Group of trees	* (with symbol)		
Centro abitato Built-up area	■ (with symbol)		
Ferrovie (una o due binari) Railroad (one or more tracks)	— (with symbol)		
Linea trasporto energia elettrica - cavo sospeso Transmission line - Overhead cable	— (with symbol)		
Recinzione Fence	— (with symbol)		
Terreno sporgente dai piani ostacoli Terrain protruding obstruction plane	— (with symbol)		

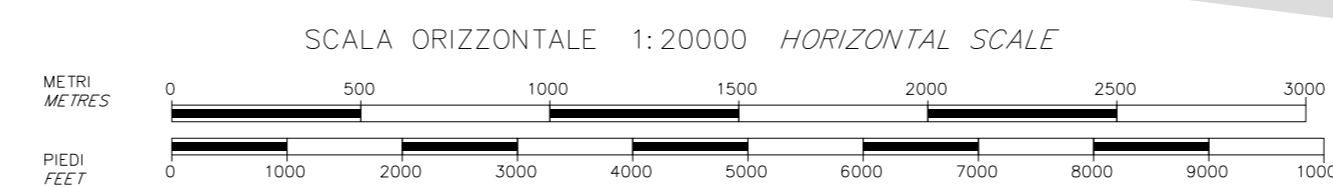
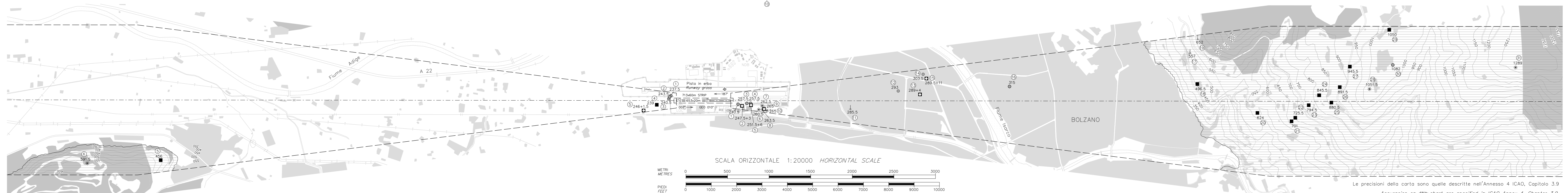

Le precisioni della carta sono quelle descritte nell'Annesso 4 ICAO, Capitolo 3.9
Accuracies on the chart are specified in ICAO Annex 4, Chapter 3.9

VARIANTI	AMENDMENT RECORD	
N	DATA DATE	REDAZIONE REVISION BY